

APPLICATION

WLAN, Home RF, Bluetooth, etc.

FEATURES

- Compact Size**
Miniaturized SMD packaged in low profile and lightweight.
- Wide Bandwidth**
- High Soldering Heat Resistance**
High quality termination allows both flow and re-flow soldering methods to be applied.
- Available in Tape and Reel Packaging for Automatic Mounting**
- Very Small Ground Clearance to Save Real Estate**

PRODUCT IDENTIFICATION

L T A - 6 0 2 5 - ### x x - B 1
① ② ③ ④

- ① Product Code
- ② Dimension Code
- ③ Series Type (### represents center frequency and xx represents material type)
- ④ Design Code

ELECTRICAL REQUIREMENTS

Part NO.	Frequency	Impedance	Bandwidth*	Gain*	VSWR	Polarization
LTA-6025-2G4S3-B1	2450MHz	50 Ohms	~100 MHz	0 dBi	2.5 max.	Linear

*Depend on PCB layout.



PRODUCT DIMENSION

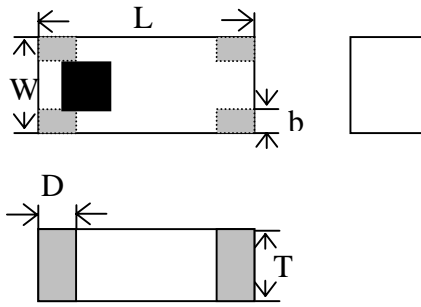

L	W	T	D
6.00±0.2	2.50±0.2	1.00±0.2	1.00±0.2
b			
0.5±0.2			

NOTE : Dimensions in mm

TERMINAL CONFIGURATION



- ① GND
- ② Feed Termination
- ③ N.C.
- ④ N.C.

MEASURING DIAGRAM

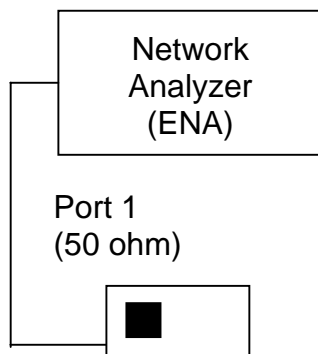

Test Instrument:
Agilent E5071A Network Analyzer

RECOMMENDED PCB LAYOUT

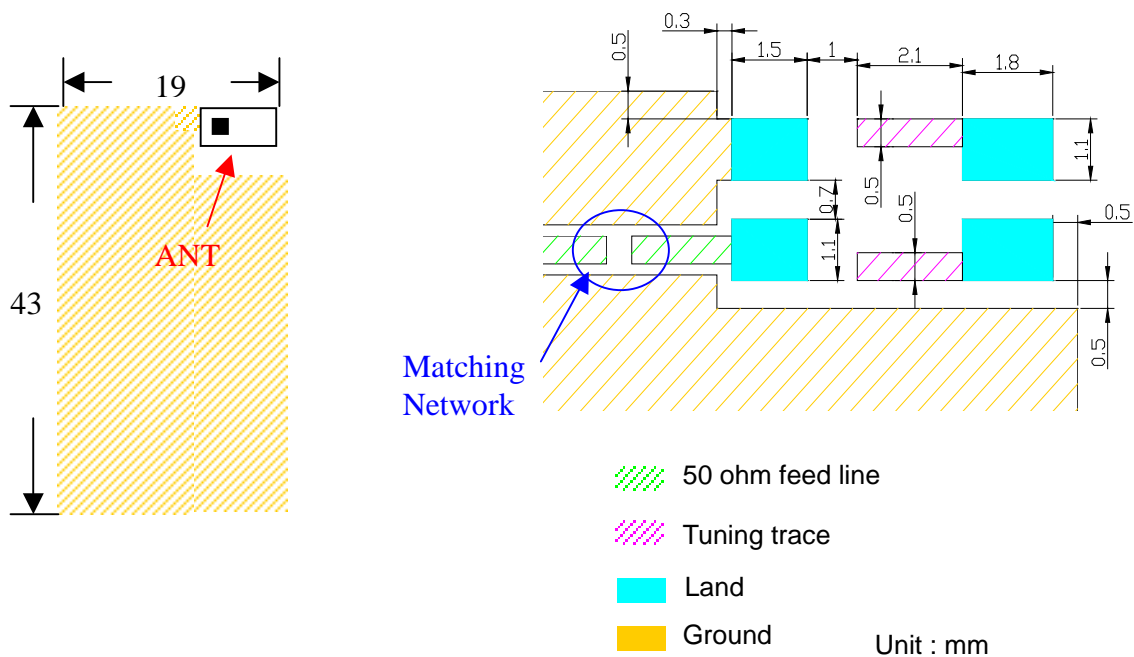

ELECTRICAL CHARACTERISTICS (T=25°C)

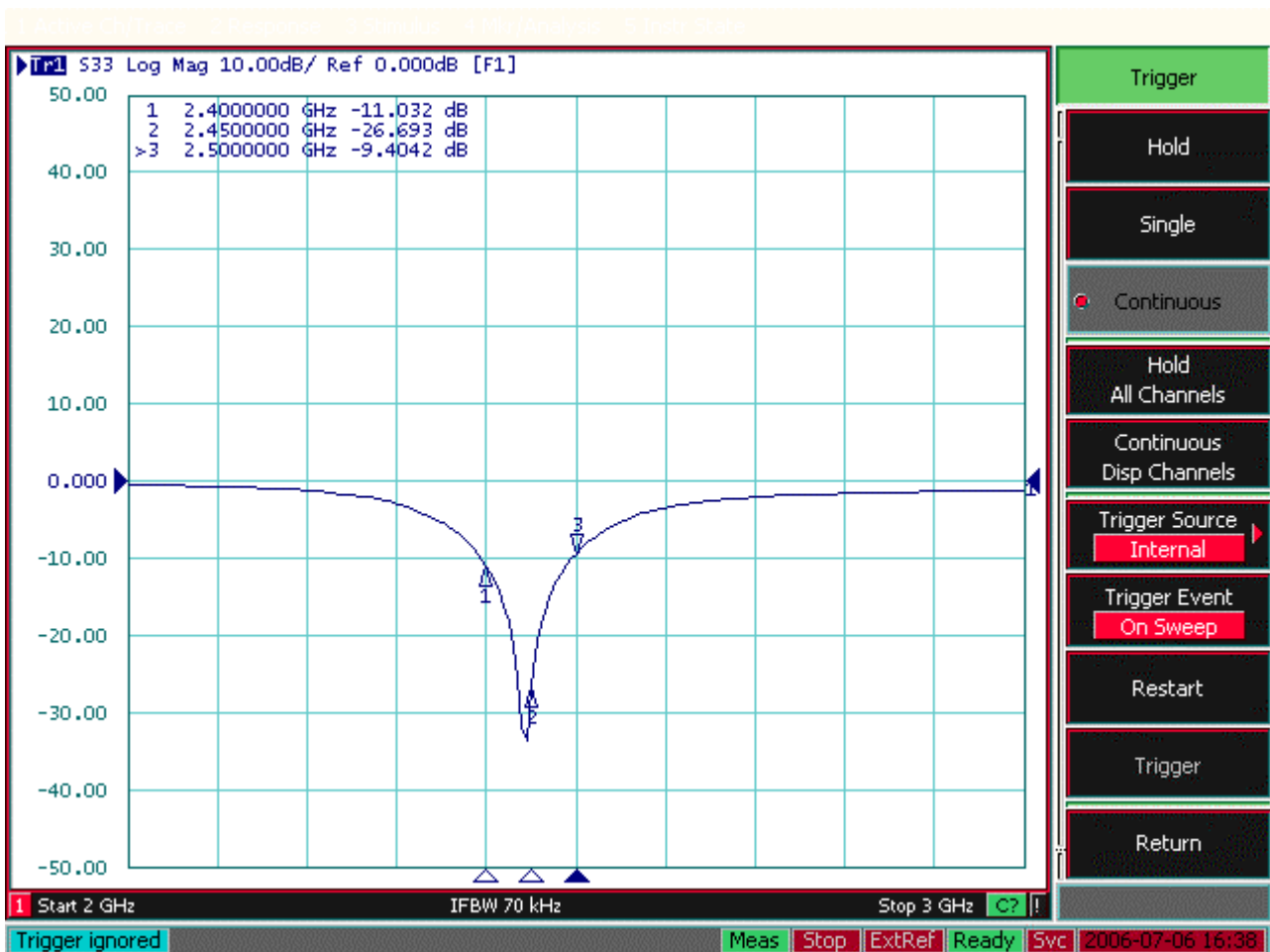

RADIATION PATTERN

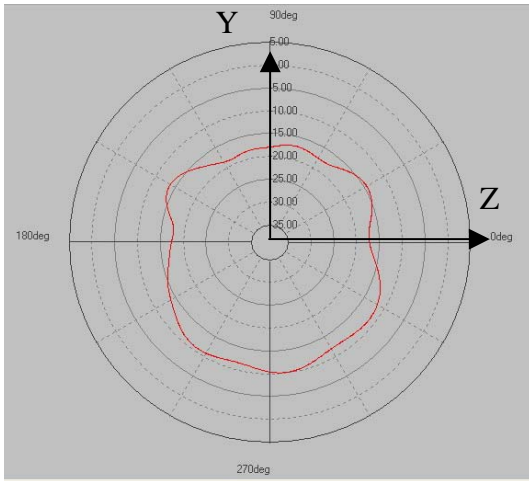

Peak Gain -10.25dBi

Y-Z Plane Horizontal

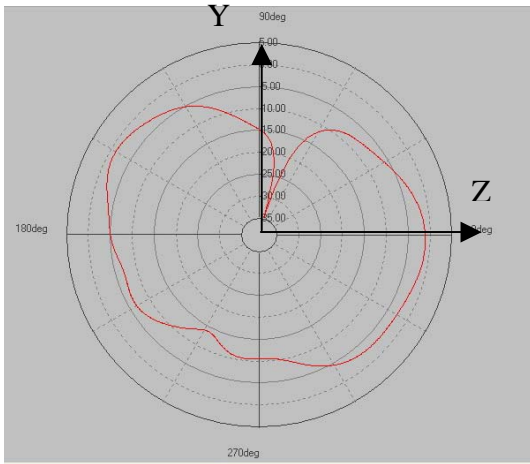
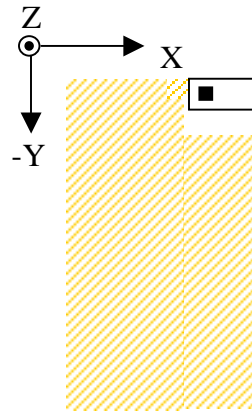

Peak Gain -1.04dBi

Y-Z Plane Vertical

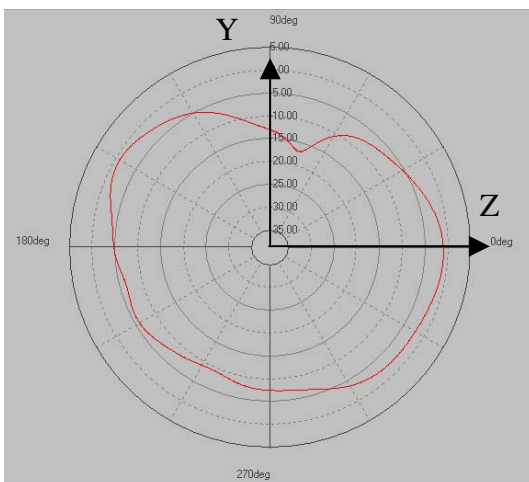
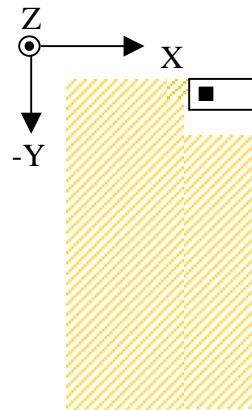

Peak Gain -0.93dBi

Y-Z Plane Total

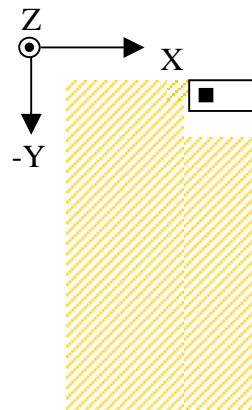

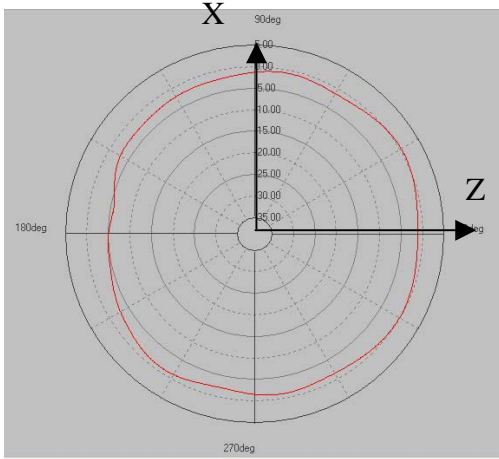

Peak Gain 0.33dBi

X-Z Plane **Horizontal**

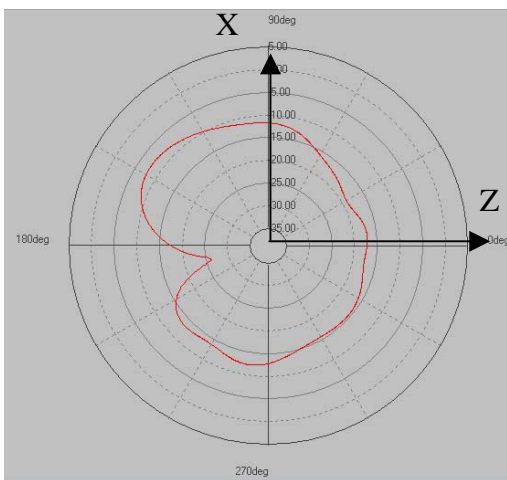
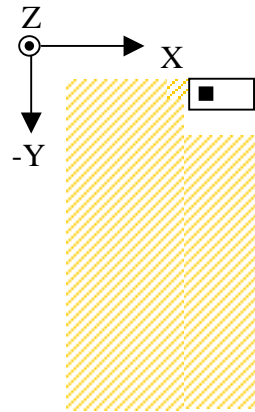

Peak Gain -7.77dBi

X-Z Plane **Vertical**

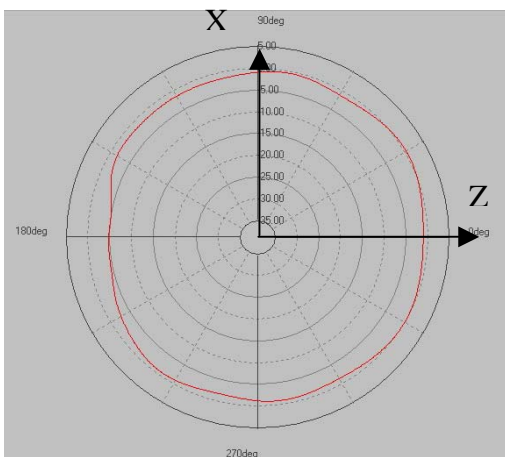
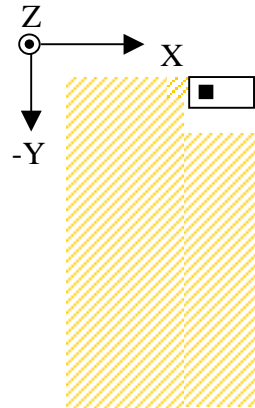

Peak Gain 0.38dBi

X-Z Plane **Total**

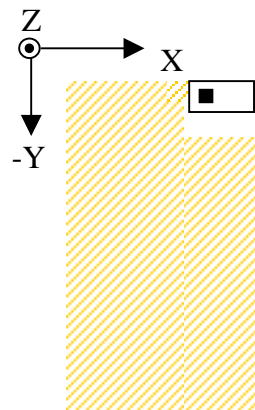

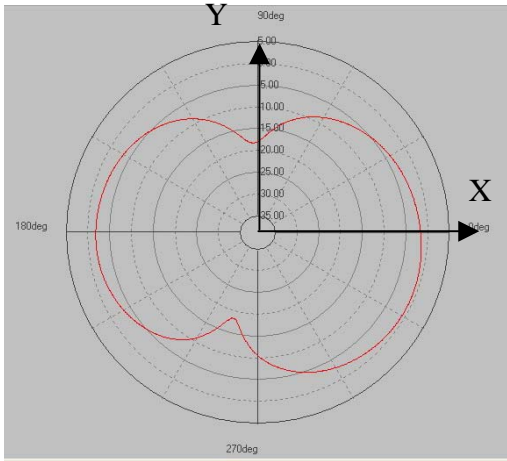

Peak Gain -0.67dBi

X-Y Plane Horizontal

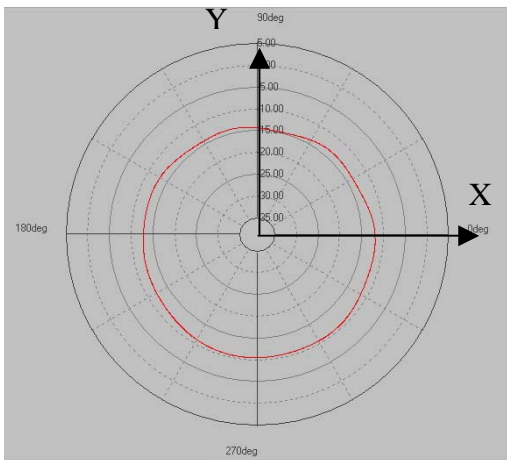
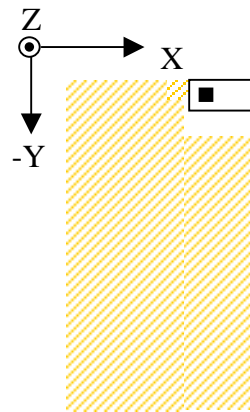

Peak Gain -10.64dBi

X-Y Plane Vertical

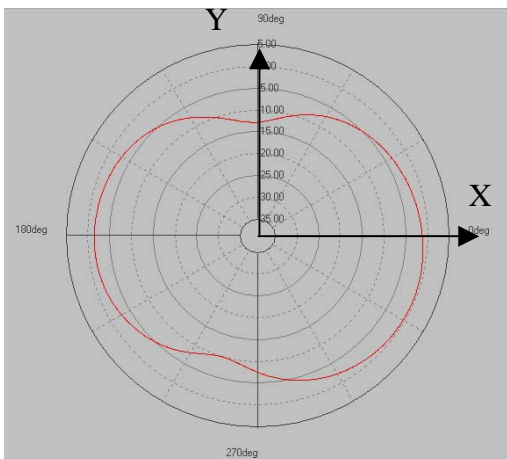
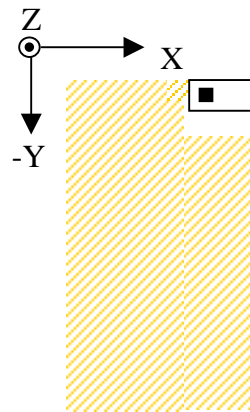

Peak Gain -0.34dBi

X-Y Plane Total

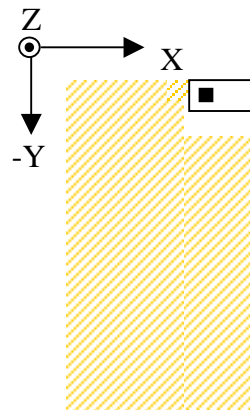

ATTENTION REGARDING PCB BENDING

- (a) PCB shall be designed so that products are not subjected to the mechanical stress for board warpage. Product shall be located in the sideway direction to the mechanical stress.

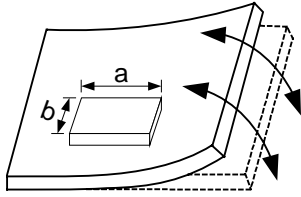

(Poor example)

Length: $a > b$

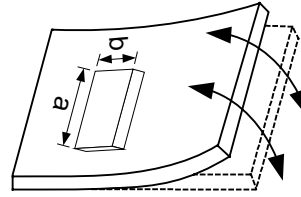

(Good example)

- (b) Products (A,B,C,D) shall be located carefully so that products are not subjected to the mechanical stress due to warping the board. Because they may be subjected to the mechanical stress in order of $A > C > B \approx D$.

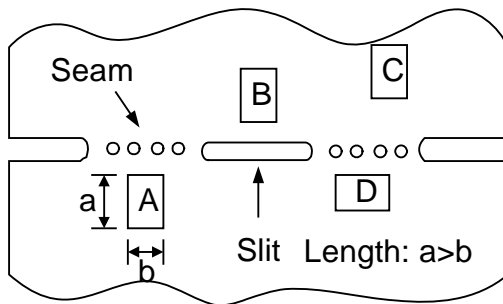

RELIABILITY TEST

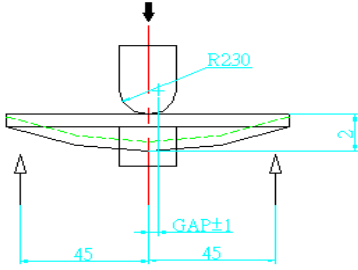
Item	Condition	Specification
Thermal shock	-40°C ~ +85°C for 100 cycles each cycle being 30 min	No apparent damage Fulfill the electrical spec. after test
Humidity resistance	85±2°C, 80~90% R.H. for 500 hours	No apparent damage Fulfill the electrical spec. after test
High temperature resistance	+85±2°C for 500 hours	No apparent damage Fulfill the electrical spec. after test
Low temperature resistance	-40±3°C for 500 hours	No apparent damage Fulfill the electrical spec. after test
Drop shock	Dropped onto printed circuit board from 100cm height three times in x, y, z directions. The terminals shall be protected.	No apparent damage
Soldering heat resistance	Preheating temperature : 150±10°C Preheating time : 1 to 2 minutes Solder bath temperature : 260±5°C Bathing time : 5±0.5 seconds	No apparent damage
Bending test onto printed circuit board	<p>Solder specimen LTCC components on the test printed circuit board (L: 100 x W: 40 x T: 1.6mm) in appended recommended PCB pattern. Apply the load in direction of the arrow until bending reaches 2 mm.</p>  <p>Unit: mm</p>	No apparent damage
Solderability	The dipped surface of the terminal shall be at least 75% covered with solder after dipped in solder bath of 235±5°C for 3±0.5 seconds.	No apparent damage

STORAGE CONDITION

The temperature should be within 0 ~ 30°C and humidity should be less than 75% RH.
The product should be used within 6 months from the time of delivery.

RECOMMENDED REFLOW SOLDERING PROFILE

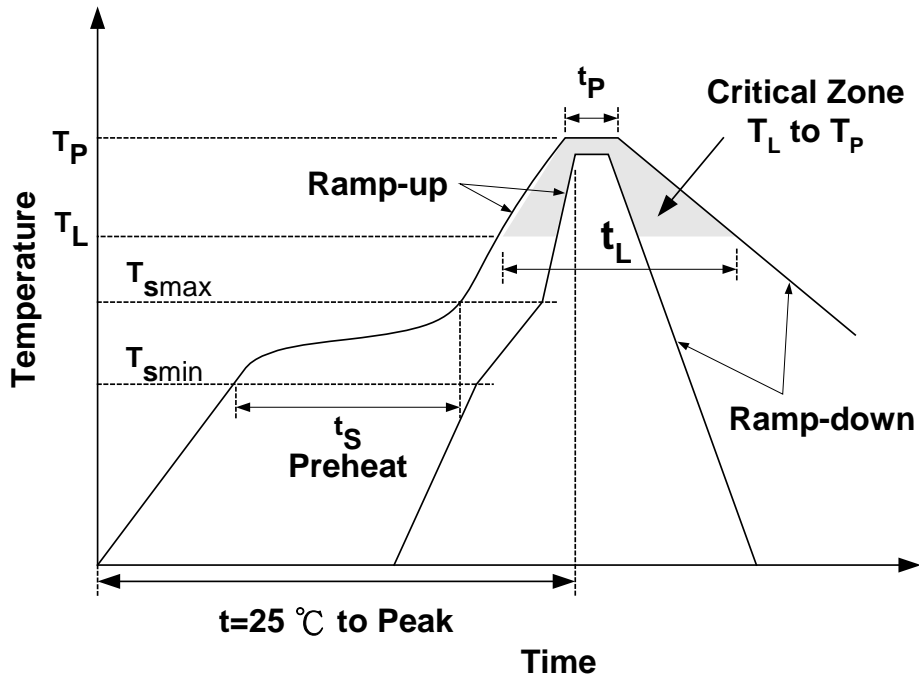

Profile Feature		Sn-Pb	Pb-Free
Preheat	ts	60~120 seconds	60~180 seconds
	Tsmin	100°C	150°C
	Tsmax	150°C	200°C
Average ramp-up rate (Tsmax to Tp)		3°C/second max.	3°C/second max.
Time main above	Temperature (TL)	183°C	217°C
	Time (tL)	60~150 seconds	60~150 seconds
Peak temperature (Tp)		230°C	250~255°C
Time within 5°C of actual peak temperature (tp)		10 seconds	10 seconds
Ramp-down rate		6°C/sec max.	6°C/sec max.
Time 25°C to peak temperature		6 minutes max.	8 minutes max.

NOTES

The contents of this data sheet are subject to change without notice. Please confirm the specifications and delivery conditions when placing your order.